



4/3" Machine Vision FA Lens 10MP/12MP



2024 V1

For customized projects please Contact us:

info@simtrum.com

www.simtrum.com

10 Mega Pixels 4/3" FA/Machine Vision Lens

SIMTRUM's 10 Mega Pixels 4/3" FA/Machine Vision Lens is designed to support a 10 MP 4/3" camera, with a focus and iris locking screw ensuring stable focusing. It delivers low distortion, sharp images, and has a compact structure, providing excellent optical performance.

Feature

- Support 10MP 3/4" Camera
- Focus and iris locking screw to ensure stable focusing
- Low imaging distortion
- Compact structure, excellent optical performance

Application

- Machine Vision
- Automatic Production
- Electronic Communication Field



Specification

Parameter		STPM-25XC10M	STPM-35XC10M	STPM-50XC10M
Resolution		10 MP;160 lp/mm (center) 100 lp/mm (corner)		
Focal Length (mm)		25	35	50
Iris Range		F2.0-F22		
Max.Sensor Size		4/3"(17.6mmX13.2mm Ø22mm)		
Field of View (Diagonal X Horizontal X Verticle)	4/3"	49.7°x40.6°x31.0°	36.6°x29.6°x22.4°	25.9°x20.9°x15.7°
	1"	35.7°x28.8°x21.8°	25.9°x20.8°x15.7°	18.2°x14.6°x11.0°
	2/3"	24.9°x20.0°x15.1°	17.9°x14.4°x10.8°	12.6°x10.1°x7.6°
Control	Focus	Manual		
	Iris	Manual		
Distortion (mm)	4/3"	-0.66%@y=11.0	-0.56%@y=11.0	-0.14%@y=11.0
	1"	-0.50%@y=8.0	-0.43%@y=8.0	-0.05%@y=8.0
	2/3"	-0.28%@y=5.5	-0.23%@y=5.5	-0.02%@y=5.5
Effective Image Dimensions (mm)		22		
Back Focal length (in air) mm		22.43	18.65	20.29
Mount		C-mount		
Filter Thread		M46.0x0.75mm	M40.5x0.5mm	M40.5x0.5mm
Working Temperature		-10°C~+50°C		

Drawings

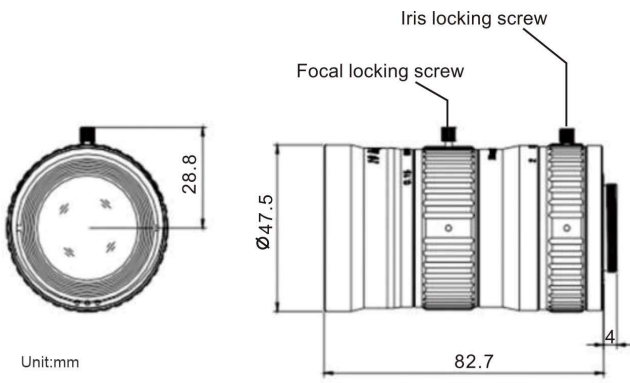

STPM-12XC10M

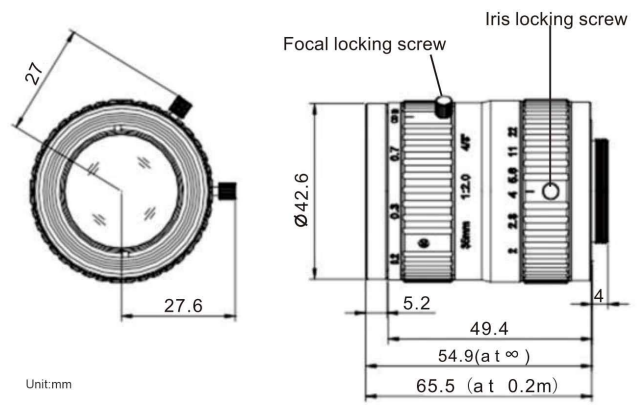

STPM-35XC10M

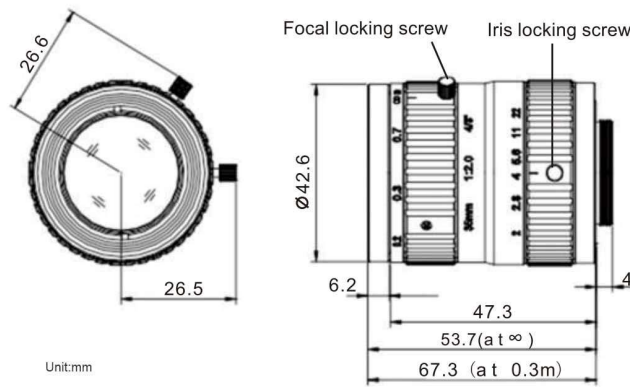

STPM-50XC10M

12 Mega Pixels 3/4” FA/Machine Vision Lens-H

SIMTRUM’s 12 Mega Pixels 4/3” FA/Machine Vision Lens is designed to support a 12 MP 4/3” camera, offering high resolution, multi-layer coating with high transmittance for effective suppression of stray light. Its compact structure and small shape make it more suitable for integrated applications, while also providing a lower distortion rate to meet various application requirements.

Feature

- High resolution
- Multi layer coating, high transmittance, effective suppression of stray light
- Large target area and wide field of vision
- Anti vibration and anti impact function

Application

- Machine Vision
- Automatic Production
- Other Industries



Specification

Parameter	STPM-12XC12M	STPM-16XC12M	STPM-25XC12M	STPM-35XC12M	STPM-50XC12M	
Resolution	12MP					
Wavelength	420-1000nm					
Focal Length (mm)	12	16	25	35	50	
Iris Range	F2.0-F22					
Max.Sensor Size	4/3"(23mm)					
Field of View (Diagonal X Horizontal X Verticle)	4/3"	89.1°x75.6°x61.2°	73.0°x61.0°x47.3°	49.8°x40.6°x31.1°	36.8°x29.7°x22.5°	26.0°x21.0°x15.8°
	1"	69.0°x57.36°x44.3°	54.2°x44.3°x33.6°	35.8°x28.9°x21.8°	26.0°x20.8°x15.8°	18.3°x14.7°x11.1°
	1/2"	37.4°x30.2°x22.7°	28.3°x22.7°x17.1°	18.3°x14.6°x11.1°	13.2°x10.6°x7.9°	9.2°x7.3°x5.6°
Control	Focus	Manual				
	Iris	Manual				
Distortion (mm)	4/3"	-2.05%@y=11.5	-1.93%@y=11.5	-0.64%@y=11.5	-0.52%@y=11.5	-0.13%@y=11.5
	1"	-1.73%@y=8.0	-1.82%@y=8.0	-0.48%@y=8.0	-0.42%@y=8.0	-0.05%@y=8.0
	1/2"	-1.01%@y=4.0	-0.55%@y=4.0	-0.15%@y=4.0	-0.12%@y=4.0	-0.01%@y=4.0
Object Size (At the closest focusing distance) mm	4/3"	319.4x262.7x204.4	195.5x145.5x107.3	157.8x125.7x94.0	121.0x96.7x72.4	118.9x95.1x71.3
	1"	235.5x189.9x143.2	125.5x99.3x73.9	109.2x87.2x65.3	84.0x67.2x50.3	82.7x66.1x49.6
	1/2"	119.8x95.9x72.0	61.3x48.9x36.6	54.4x43.5x32.6	42.0x33.5x25.1	41.4x33.1x24.9
Focus Range	0.15m~∞	0.1m~∞	0.15m~∞	0.2m~∞	0.3m~∞	
Back Focal length(in air) mm	18.8	21	22	18	20	
Mount	C-mount					
Filter Thread	M77.0xP0.75	M58.0xP0.75	M46.0xP0.75	M46.0xP0.75	M46.0xP0.75	
Working Temperature	-20°C~+60°C					
Weight (g)	438g	339g	248g	207g	219g	

Specification

Model	WorkingDistance	Magnification	FOV					
			4/3"		1"		2/3"	
			H(18mm)	V(13.5mm)	H(8.8mm)	V(6.6mm)	H(6.4mm)	V(4.8mm)
STPM-12XC12M	150mm	-0.0692X	285.7808	214.3356	139.72	104.79	101.61	76.21
	200mm	-0.0537X	367.9024	275.9268	179.86	134.9	130.81	98.11
	250mm	-0.0438X	450.0256	337.5192	220.01	165.01	160.01	120.01
	300mm	-0.0370X	532.1472	399.1104	260.16	195.12	189.21	141.91
	350mm	-0.0321X	614.2704	460.7028	300.31	225.23	218.41	163.81
	400mm	-0.0283X	696.392	522.294	340.46	255.34	247.61	185.7
	450mm	-0.0253X	778.5152	583.8864	380.61	285.46	276.81	207.6
	500mm	-0.0229X	860.6368	645.4776	420.76	315.57	306	229.5
	550mm	-0.0209X	942.7584	707.0688	460.9	345.68	335.2	251.4
	600mm	-0.0192X	1024.8816	768.6612	501.05	375.79	364.4	273.3
STPM-16XC12M	100mm	-0.13187X	141.9568	106.4676	69.4	52.05	37.86	37.86
	150mm	-0.09332X	200.6016	150.4512	98.07	73.55	53.49	53.49
	200mm	-0.07224X	259.1536	194.3652	126.7	95.02	69.11	69.11
	250mm	-0.05893X	317.6752	238.2564	155.31	116.48	84.71	84.71
	300mm	-0.04976X	376.1744	282.1308	183.91	137.93	100.31	100.31
	350mm	-0.04307X	434.6608	325.9956	212.5	159.38	115.91	115.91
	400mm	-0.03796X	493.1632	369.8724	241.1	180.83	131.51	131.51
	450mm	-0.03394X	551.6016	413.7012	269.67	202.25	147.09	147.09
	500mm	-0.03068X	610.1024	457.5768	298.27	223.7	162.69	162.69
	550mm	-0.028X	668.6352	501.4764	326.89	245.17	178.3	178.3
600mm	-0.02575X	727.1264	545.3448	355.48	266.61	193.9	193.9	
STPM-25XC12M	150mm	-0.1479X	124.4128	93.3096	60.82	45.62	33.18	33.18
	200mm	-0.11394X	161.4944	121.1208	78.95	59.21	43.07	43.07
	250mm	-0.09271X	198.472	148.854	97.03	72.77	52.93	52.93
	300mm	-0.07817X	235.3824	176.5368	115.08	86.31	62.77	62.77
	350mm	-0.06758X	272.2848	204.2136	133.12	99.84	72.61	72.61
	400mm	-0.05952X	309.1328	231.8496	151.13	113.35	82.44	82.44
	450mm	-0.05318X	346.008	259.506	169.16	126.87	92.27	92.27
	500mm	-0.04806X	382.8528	287.1396	187.17	140.38	102.09	102.09
	550mm	-0.04384X	419.688	314.766	205.18	153.89	111.92	111.92
	600mm	-0.0403X	456.52	342.39	223.19	167.39	121.74	121.74

Specification

Model	WorkingDistance	Magnification	FOV					
			4/3"		1"		2/3"	
			H(18mm)	V(13.5mm)	H(8.8mm)	V(6.6mm)	H(6.4mm)	V(4.8mm)
STPM-35XC12M	200mm	-0.19139X	96.56	72.42	47.2	35.4	34.33	25.75
	250mm	-0.15031X	122.95	92.21	60.11	45.08	43.71	32.79
	300mm	-0.12375X	149.34	112	73.01	54.76	53.1	39.82
	350mm	-0.10516X	175.73	131.8	85.91	64.43	62.48	46.86
	400mm	-0.09143X	202.12	151.59	98.81	74.11	71.86	53.9
	450mm	0.08087X	228.51	171.39	111.72	83.79	81.25	60.94
	500mm	0.0725X	254.91	191.18	124.62	93.47	90.63	67.97
	550mm	-0.0657X	281.3	210.97	137.52	103.14	100.02	75.01
	600mm	-0.06006X	307.7	230.78	150.43	112.82	109.41	82.05
STPM-50XC12M	300mm	-0.194X	95.1632	71.3724	46.52	34.89	33.84	25.38
	350mm	-0.163X	113.6352	85.2264	55.55	41.67	40.4	30.3
	400mm	-0.140X	132.1136	99.0852	64.59	48.44	46.97	35.23
	450mm	-0.123X	150.5904	112.9428	73.62	55.22	53.54	40.16
	500mm	-0.109X	169.0832	126.8124	82.66	62	60.12	45.09
	550mm	-0.099X	187.5472	140.6604	91.69	68.77	66.68	50.01
	600mm	-0.090X	206.0272	154.5204	100.72	75.54	73.25	54.94
	650mm	-0.082X	224.5056	168.3792	109.76	82.32	79.82	59.87
	700mm	-0.076X	242.984	182.238	118.79	89.09	86.39	64.8

MTF Curve

STPM-12XC12M

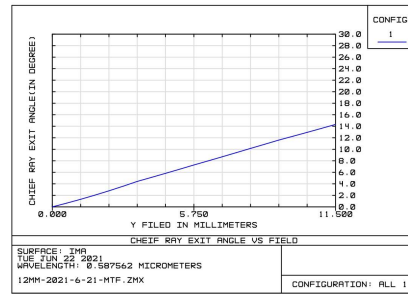
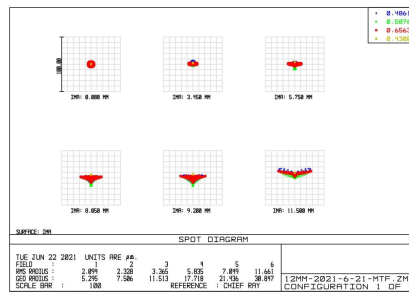
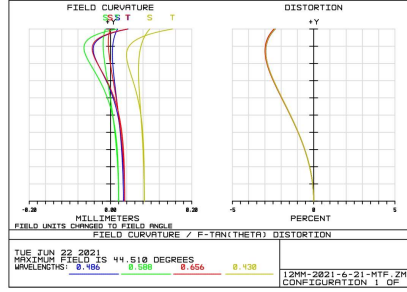
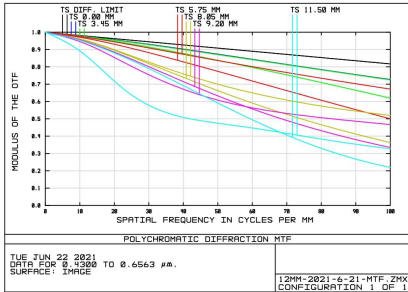

STPM-16XC12M

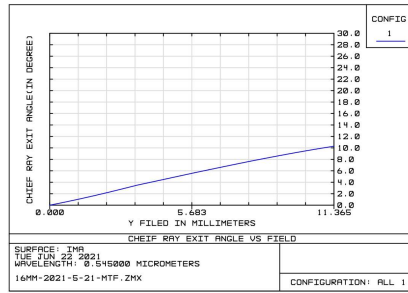
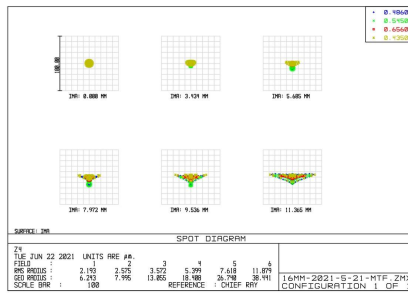
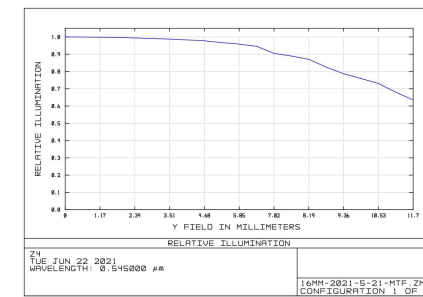
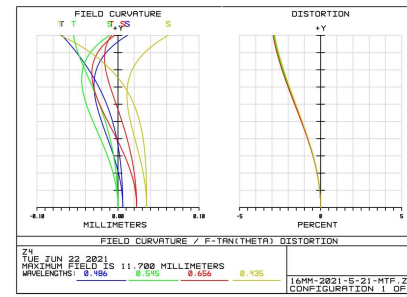
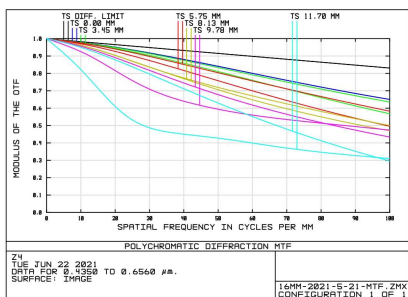

MTF Curve

STPM-25XC12M

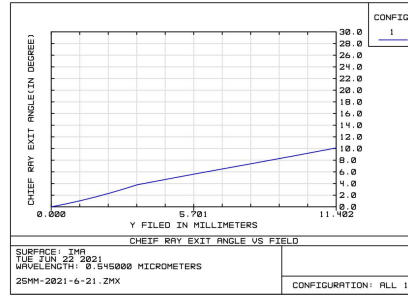
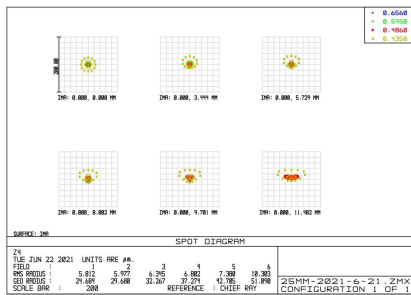
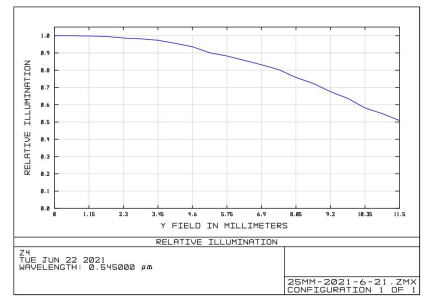
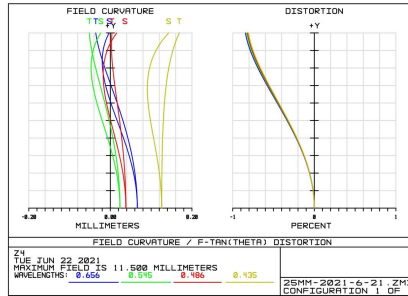
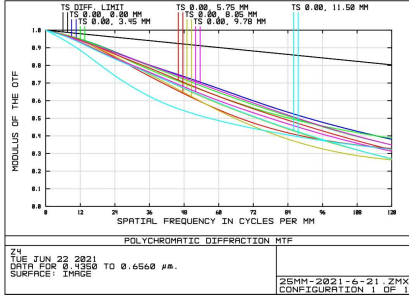

STPM-35XC12M

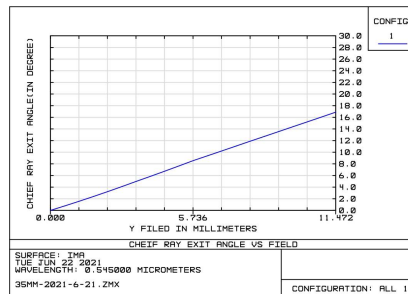
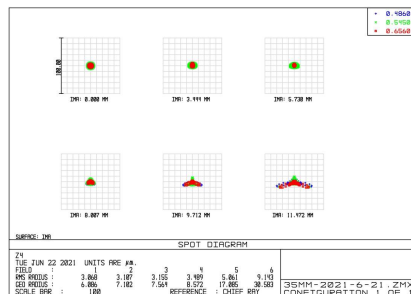
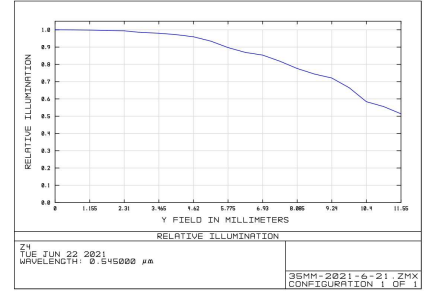
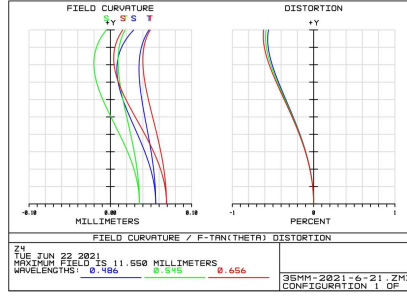
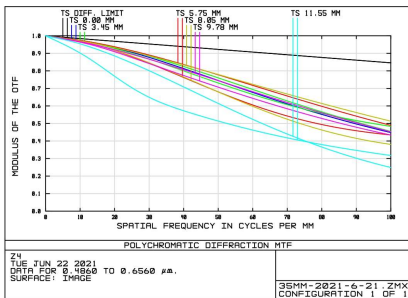

MTF Curve

STPM-50XC12M

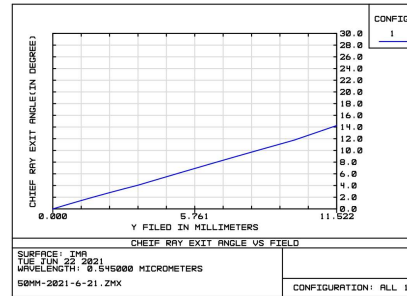
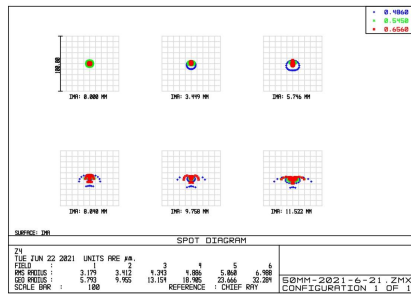
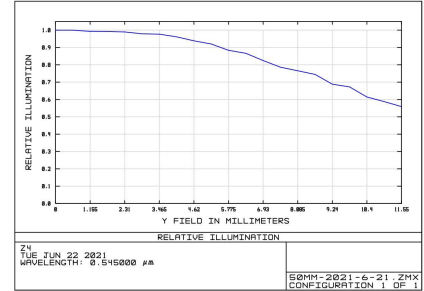
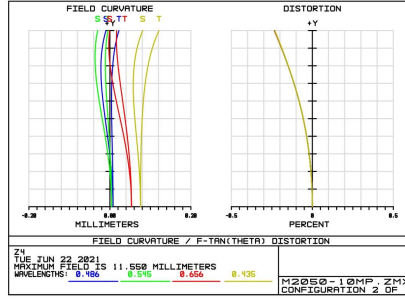
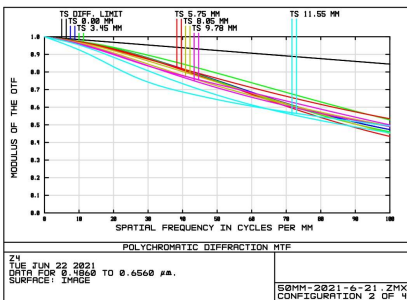

Drawings

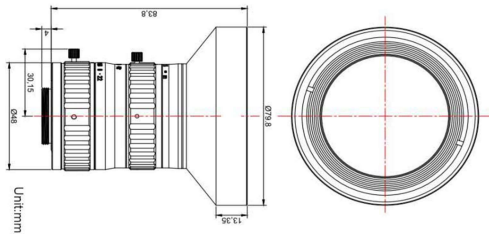

STPM-12XC12M

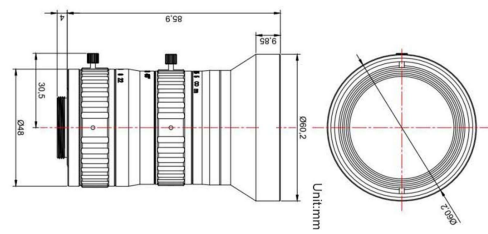

STPM-16XC12M

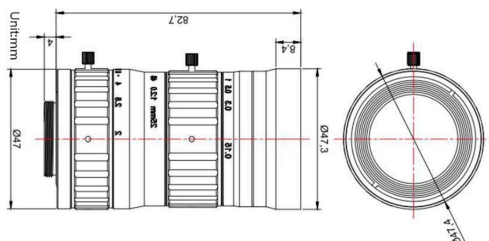

STPM-25XC12M

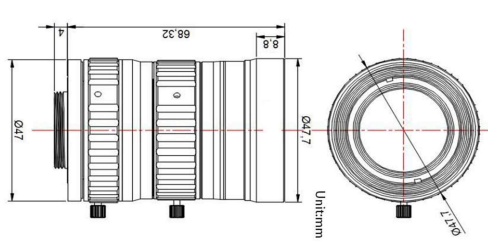

STPM-35XC12M

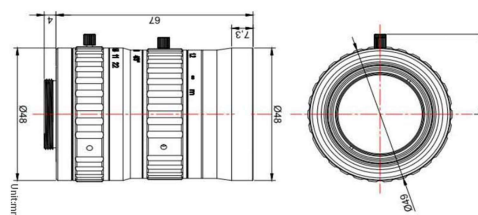

STPM-50XC12M