

**FOR INFORMATION ONLY
NOT FOR MANUFACTURING
PURPOSES**

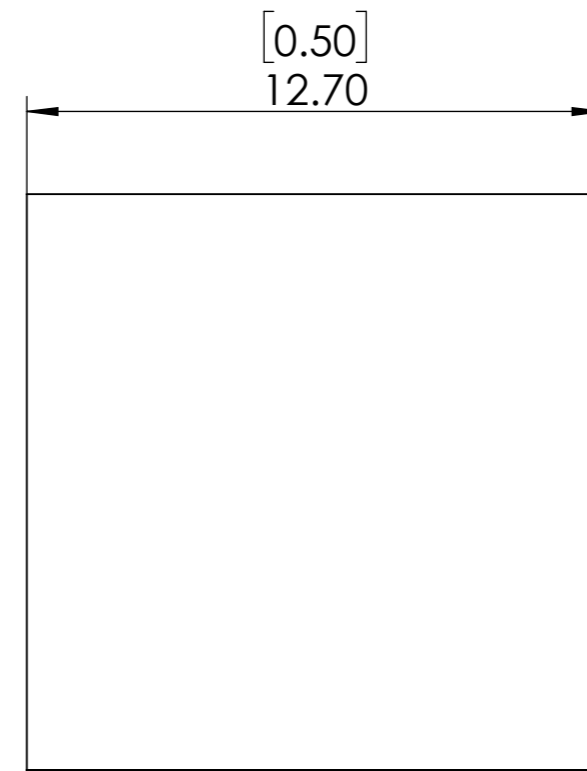
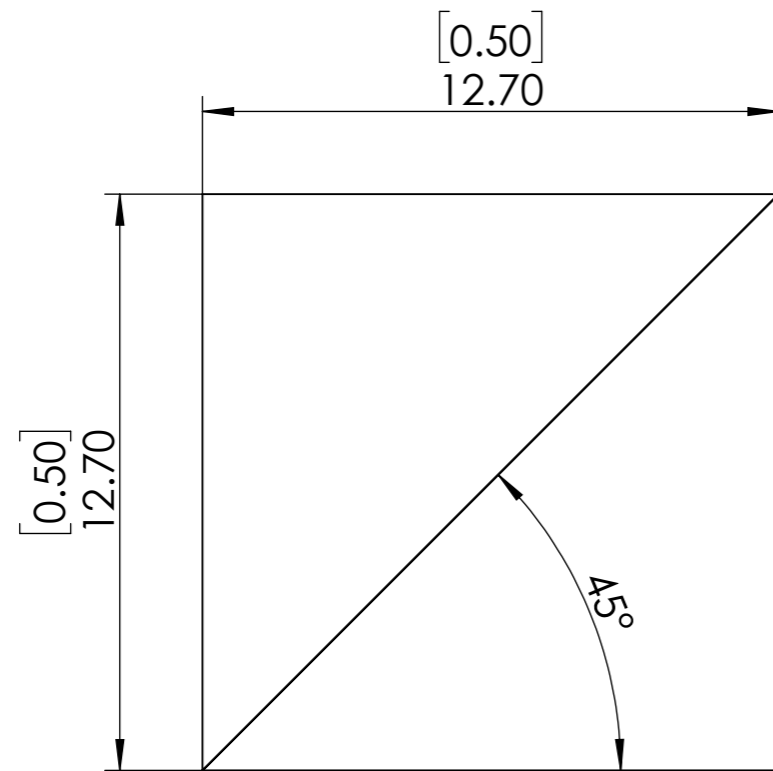
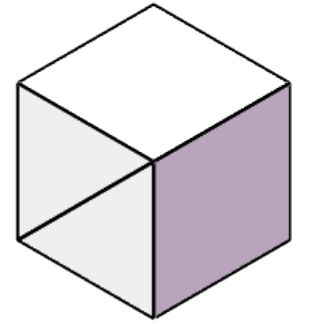

- 1.CLEAR APERTURE: >90%
- 2.SURFACE FLATNESS: < $\lambda/4$
- 3.SURFACE QUALITY: 40-20
- 4.AOI:0
- 5.WAVELENGTH:532 nm
- 6.SPLIT RATIO: 45:45±5%
- 7.POLARIZATION: |Rs-Rp| <6%, |Ts-Tp| <6%
- 8.TRANSMITTED BEAM DEVIATION: <3 arcmin
- 9.REFLECTED BEAM DEVIATION: <3 arcmin
- 10.DIMENSION TOLERANCE:± 0.15 mm
- 11.COATING:Ravg < 0.5% @ 532nm

SIMTRUM www.simtrum.com	
Title:	Laser Line Non-Polarizing Beamsplitter Cube
Material:	BK7
Part No:	BK7-LNPBSC-12.7-532