

**FOR INFORMATION ONLY
NOT FOR MANUFACTURING PURPOSES**

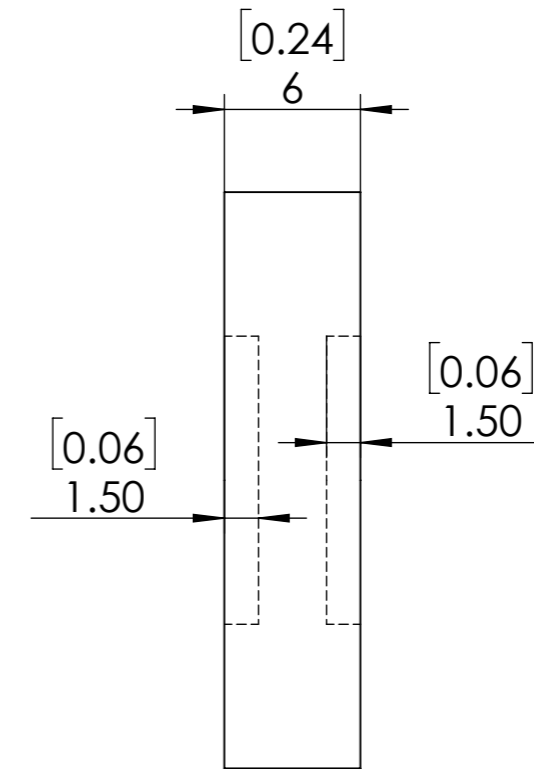
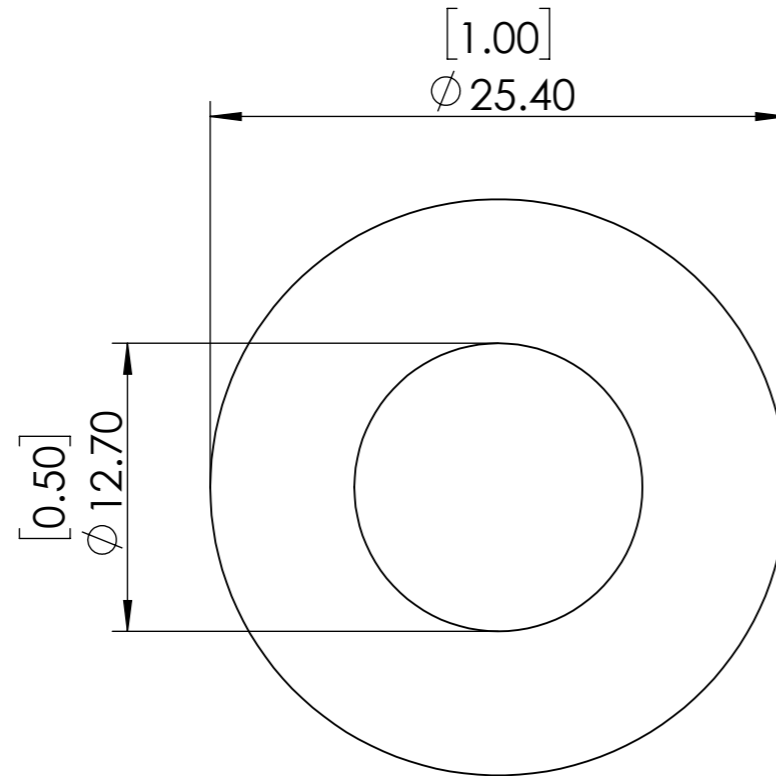

1. UNMOUNTED DIAMETER: 12.7 mm
2. DESIGN WAVELENGTH: 3500 nm
3. RETARDATION: $\lambda/4$
4. RETARDATION TOLERANCE: $<\lambda/100$
5. WAVEFRONT DISTORTION: $<\lambda/4@633\text{nm}$
6. SURFACE QUALITY: 40/20
7. CLEAR APERTURE: $>11.5\text{mm}$
8. PARALLELISM: <5 arcsec
9. COATING: $R<0.5\%$ @3500nm

SIMTRUM www.simtrum.com	
Title:	Optically Contacted Middle Infrared Zero Order Quarter Waveplate
Material:	MgF2
Part No:	MgF2-MIRQWP-12.7-3500-M