

**FOR INFORMATION ONLY NOT FOR
MANUFACTURING PURPOSES**

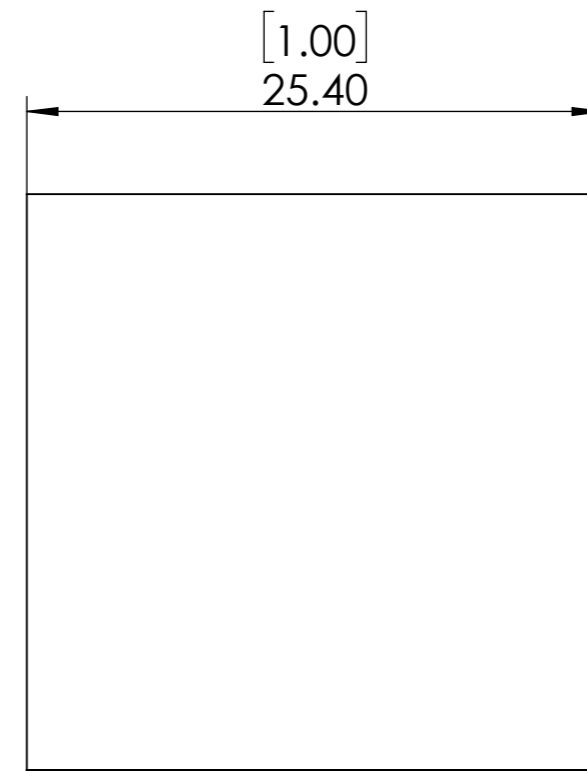
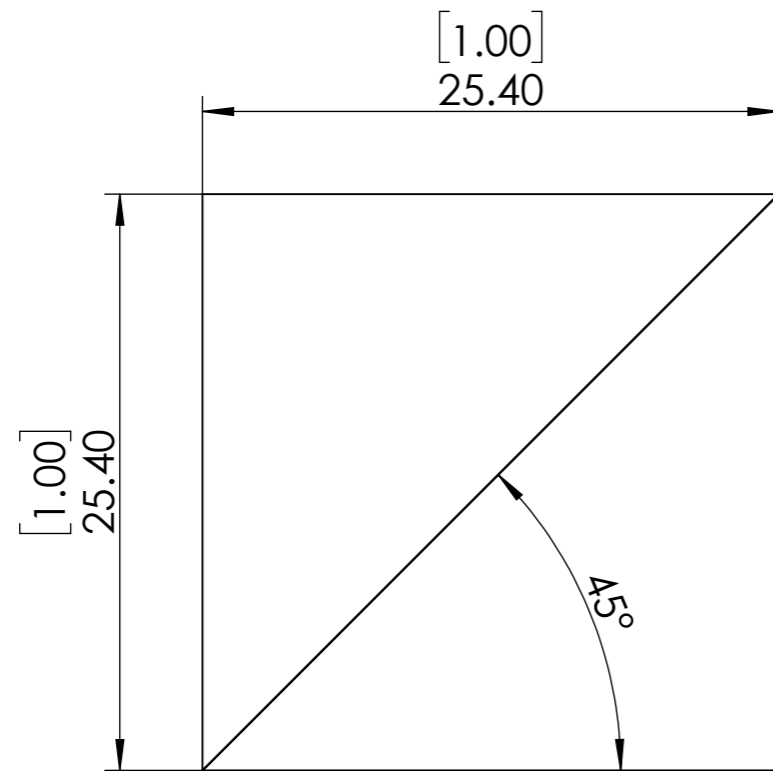
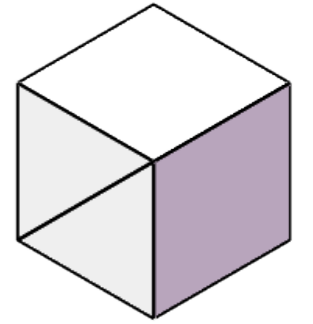

1. CLEAR APERTURE: >90%
2. SURFACE FLATNESS: $<\lambda/4@633\text{nm}$
3. SURFACE QUALITY: 40-20
4. AOI: 0 degree
5. SPLIT RATIO: 45:45±5%
6. POLARIZATION: $|R_s - R_p| < 6\%$, $|T_s - T_p| < 6\%$
7. TRANSMITTED BEAM DEVIATION: $< 3 \text{ arcmin}$
8. REFLECTED BEAM DEVIATION: $< 3 \text{ arcmin}$
9. DIMENSION TOLERANCE: $\pm 0.2 \text{ mm}$
10. COATING: $R_{\text{avg}} < 0.5\% @ 900-1200\text{nm}$

SIMTRUM www.simtrum.com	
Title:	Broadband Non-Polarizing Beamsplitter Cubes
Material:	BK7
Part No:	BK7-NPBSC-25.4-900-1200